

# SCA1000 and SCA1020 Series

## Accelerometer

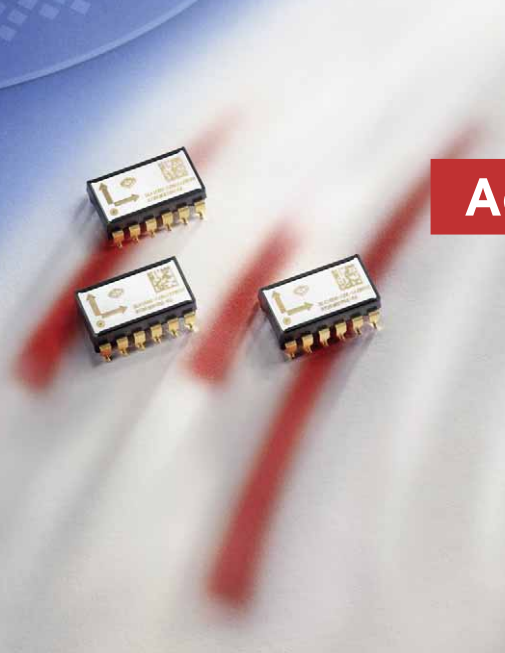

### FEATURES

- 2-axis measurement: SCA1000 for X - Y measurement and SCA1020 for Z - Y measurement
- Available range ±1.7 g
- Interchangeable with SCA610/SCA620 (see interchangeability drawing below)
- Over damped sensing element to control frequency response
- SMD DIL-12 lead-free component
- Compatible with lead-free reflow soldering process
- Advanced internal and external connection failure detection
- Digitally activated electrostatic self-test
- Continuous memory parity check
- Single +5 V supply; two ratiometric analog voltage outputs
- Serial Peripheral Interface (SPI) compatible digital output (11 bits)
- Internal temperature sensor, accessible via SPI

### BENEFITS

- Excellent reliability and stability over time and temperature
- High resolution and low noise
- Wide operating temperature range
- Outstanding overload and shock durability

### APPLICATIONS

- 2-axis acceleration measurements
- 2-axis platform leveling
- Inclination based position measurement
- 360 ° vertical orientation measurement

For customized product, please contact VTI Technologies

### ELECTRICAL CHARACTERISTICS

Parameter	Condition	Min	Typ.	Max	Units
Supply voltage Vdd <sup>(1)</sup>		4.75	5.0	5.25	V
Current consumption	Vdd = 5 V; No load			5	mA
Analog resistive output load	Vout to Vdd or Vss	10			kOhm
Analog capacitive output load				20	nF
Digital output load	@ 500 kHz			1	nF
SPI clock frequency				500	kHz
AD conversion time			150		µs
Data transfer time	@500 kHz clock		38		µs

### PERFORMANCE CHARACTERISTICS

Parameter	Condition	SCA1000-DO1	SCA1020-DO2	Units
Measuring range <sup>(2)</sup>	Nominal	±1.7	±1.7	g
Measuring direction relative to mounting plane <sup>(12)</sup>	See note 12.	"X"= parallel "Y" =parallel	"Z"= perpendicular "Y"= parallel	
Zero point <sup>(3,12)</sup>	Mounting position	Vdd/2	Vdd/2	V
Sensitivity <sup>(4,12)</sup>	@ room temperature	1.2	1.2	V/g
Zero point error over temperature <sup>(5)</sup>	-25...85 °C typical	±70	±70	mg
	-40...125 °C	±100	±100	mg
Sensitivity error over temperature <sup>(6)</sup>	-25...85 °C typical	±3	±3	%
	-40...125 °C	±4	±4	%
Typical non-linearity <sup>(7)</sup>	Over measuring range	±20	±20	mg
Cross-axis sensitivity <sup>(10)</sup>	@ room temperature	3.5	3.5	%
Frequency response -3dB <sup>(8)</sup>	@ -40...125 °C	50±30 Hz	50±30 Hz	Hz
Ratiometric error <sup>(9)</sup>	Vdd = 4.75...5.25 V	2	2	%
Output noise density <sup>(11)</sup>	From DC...100 Hz	80	80	µg/√Hz
Digital output resolution	FS	11	11	Bits

**VDD = 5.00V, UNLESS OTHERWISE SPECIFIED**

Note 1 100 nF supply by-pass capacitor is needed.

Note 2 Measuring directions in parallel to mounting plane, arrows showing positive acceleration direction.

Note 3 Zero point specified as Voffset = Vout(0 g) [ V ]. See note 12.

Note 4 Sensitivity specified as Vsens = (Vout(+1 g) - Vout(-1 g))/2 [ V/g ]. See note 12.

Note 5 Zero point error specified as Zero point error = (Vout(0 g) - Vdd/2) / Vsens [ g ] Vsens = Nominal sensitivity Vdd/2 = Nominal offset.

Note 6 Sensitivity error specified as Sensitivity error = { [Vout(+1 g)-Vout(-1 g)] / 2 - Vsens\_nom } / Vsens\_nom x 100 % [ % ] Vsens\_nom = nominal sensitivity See note 12.

Note 7 From straight line through +1 g and -1 g points.

Note 8 The output has true DC (0 Hz) response.

Note 9 The ratiometric error is specified as:  $RE = 100\% \times \left( 1 - \frac{V_{out}(@V_x) \times 5.00V}{V_x \times V_{out}(@5V)} \right)$

Note 10 The cross-axis sensitivity determines how much acceleration, perpendicular to the measuring axis, couples to the output. The total crossaxis sensitivity is the geometric sum of the sensitivities of the two axis which are perpendicular to the measuring axis. The angular alignment error between channels 1 and 2 is included into the cross axis error.

Note 11 Typical figure. In addition, supply voltage noise couples to the output due to the ratiometric nature of the accelerometer.

Note 12 Measuring directions.

## MEASURING DIRECTIONS

### SCA1000 ( X - Y Configuration)

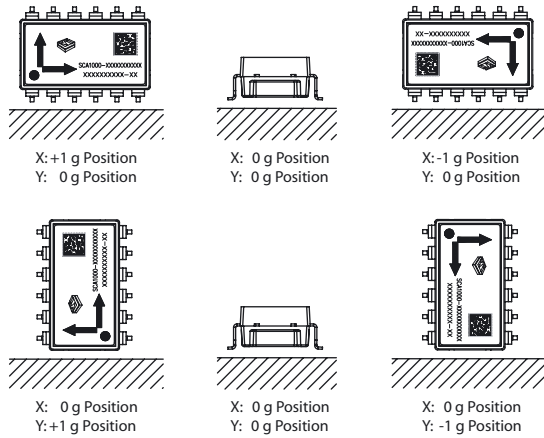

### SCA1020 ( Z - Y Configuration)

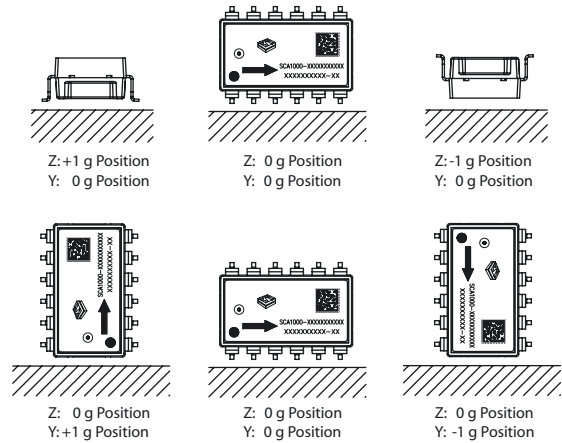

## ABSOLUTE MAXIMUM RATINGS

Parameter	Value	Unit
Acceleration (powered or non powered)	20 000	g
Supply voltage	-0.3 V to +5.5 V	V
Voltage at input/output pins	-0.3 V to (V <sub>dd</sub> +0.3 V)	V
Storage temperature range	-55...125	°C

## DIMENSIONS

The accelerometer weighs < 1.2 g.  
The size of the part is approximately (w x h x l) 9 x 5 x 16 mm. Pin pitch is standard 100 mils.

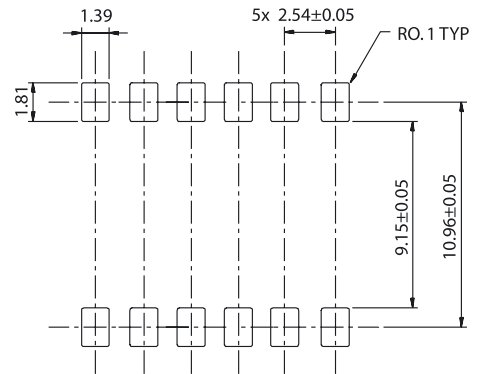
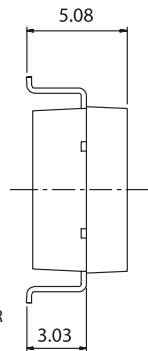
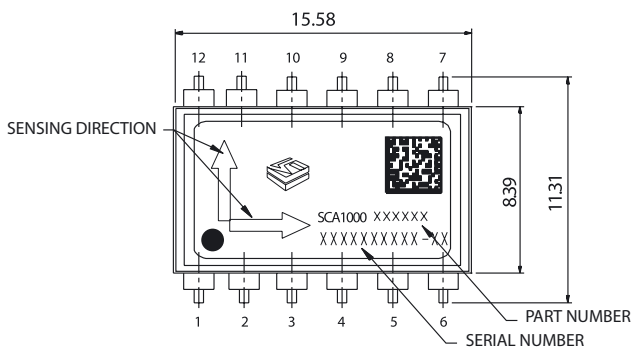

Acceleration in the direction of the arrow will increase the output voltage.

## ELECTRICAL CONNECTION

## RECOMMENDED CIRCUIT

Pin#	Pin Name	I/O	Connection
1	SCK	Input	Serial clock
2	NC	NC	Factory only
3	MISO	Output	Master in slave out; data output
4	MOSI	Input	Master out slave in; data input
5	Out_2	Output	Channel 2 Output (Y-axis)
6	VSS	Power	Negative supply voltage (VSS)
7	CSB	Input	Chip select (active low)
8	NC	NC	Factory only
9	ST_2	Input	Self test input for Channel 2
10	ST_1	Input	Self test input for Channel 1
11	Out_1	Output	Channel 1 output (X or Z-axis)
12	VDD	Power	Positive supply voltage (VDD)

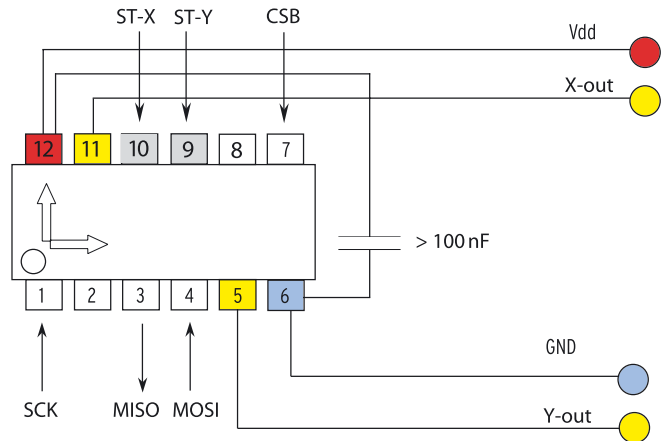

Self test can be activated applying logic "1" (positive supply voltage level) to ST pin (pin 9 and 10). If ST feature is not used pins 9 and 10 must be left floating or connected to GND.

## INTERCHANGEABILITY WITH SCA610 / SCA620

When SCA1000 / 1020 is used in Analog mode and the PCB is designed correctly the SCA610 / 620 and SCA1000 / 1020 are interchangeable. If the PCB layout is designed for SCA1000 / 1020, then SCA610 / 620 can be used for single axis applications. The output of SCA610 / 620 corresponds to the output of channel 1 in the SCA1000 / 1020.

